

Crouton.

Big on privacy, even bigger on style. Crouton is a tackable side screen. Easily attach to any desk to create visual and acoustical barriers between neighbors.

DIMENSIONS

Overall: 24"W x 14"H (Above Surface)
Compatible Surface Thickness: 1 — 1.25" thick surface

STYLES

Corner: Square | Radius

FINISHES *(Refer to Pair Palette)*

Screen: Wool
Frame: Metal
Stitching: Charcoal Grey

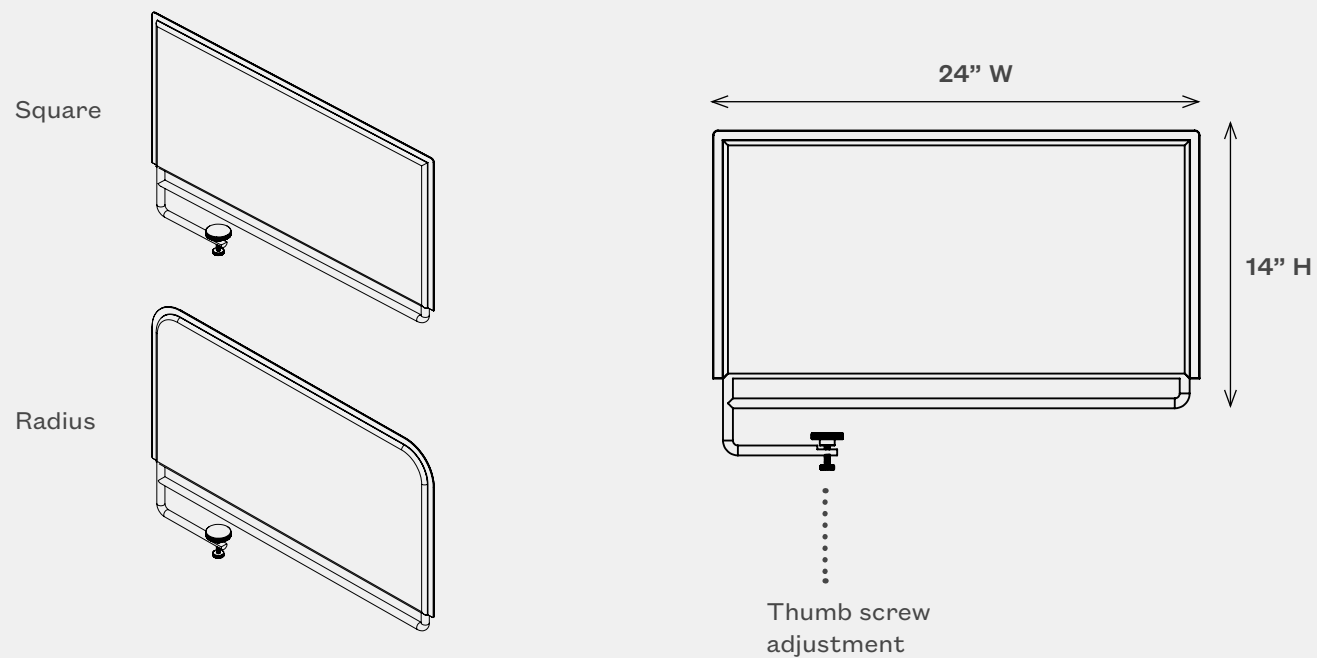

VENEER

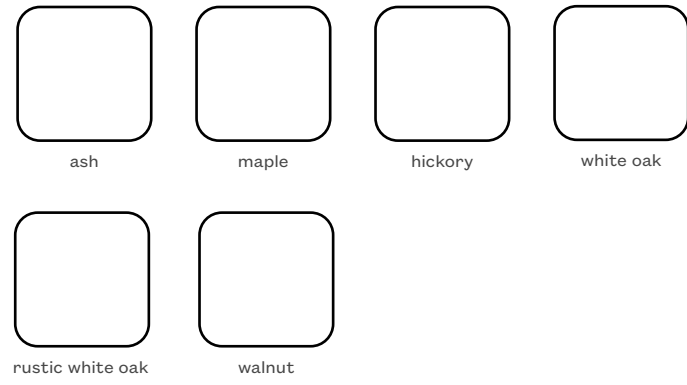

WRAPPED LAMINATE

**woodgrains contain texture*

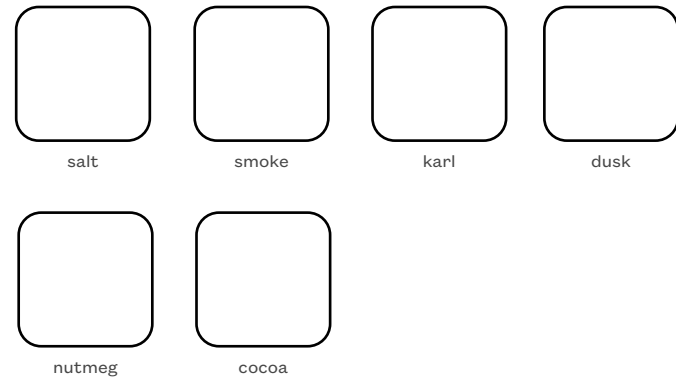

SOFT TOUCH LAMINATE



LAMINATE

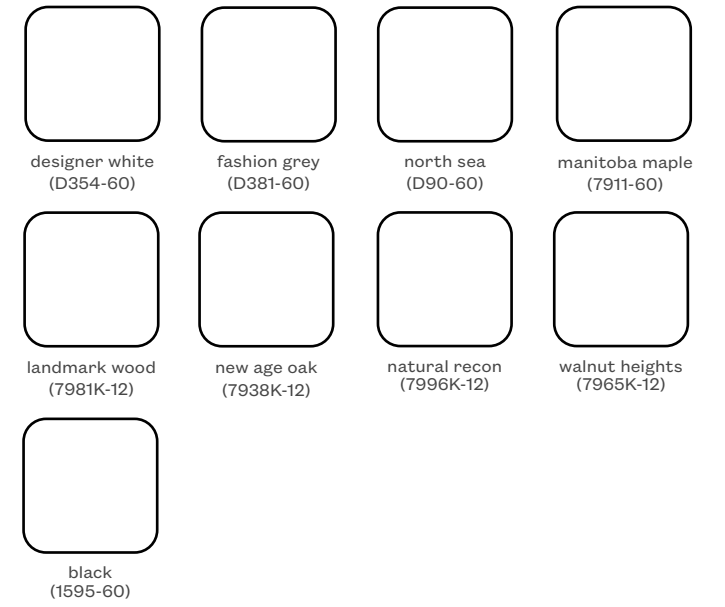

METAL



WOOL

**additional colorways available at a premium*



PET

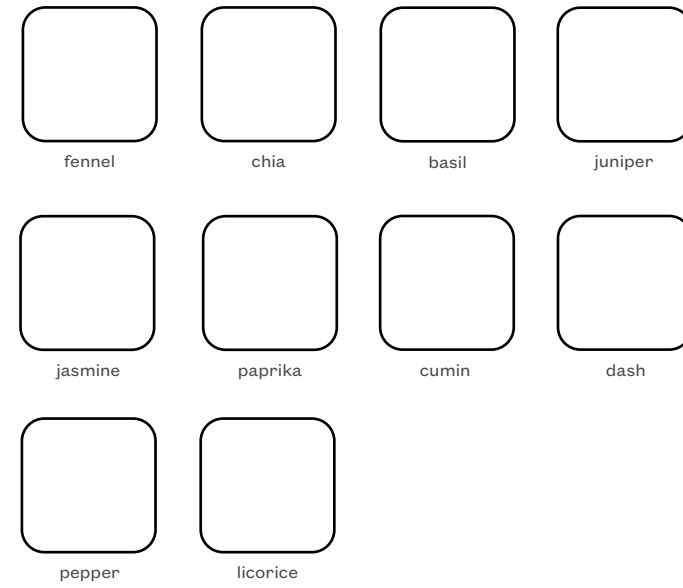

MISCELLANEOUS

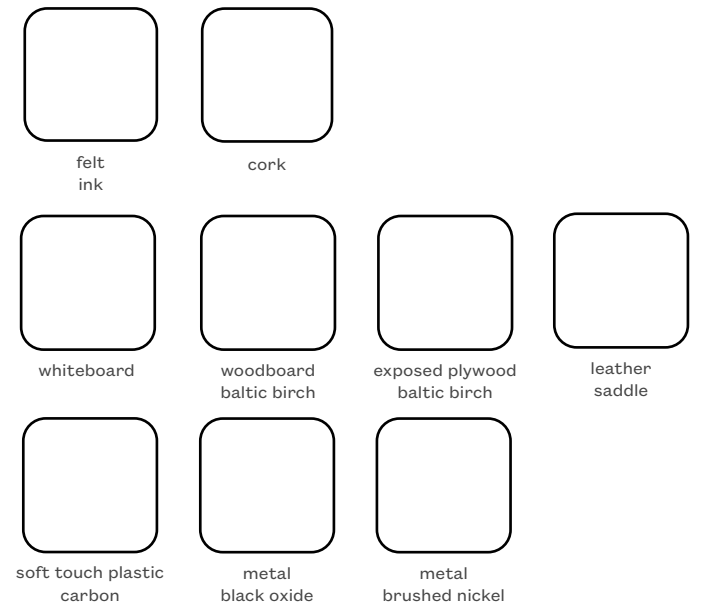

SOFT TOUCH GLASS

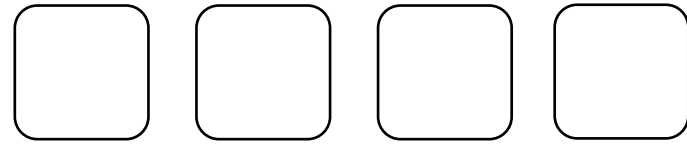

olive storm ash gumby

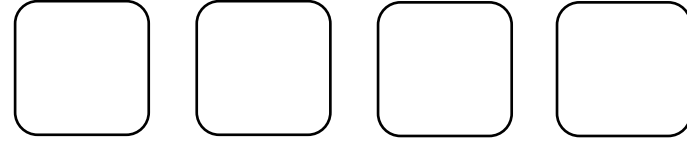

wave apollo carbon abyss

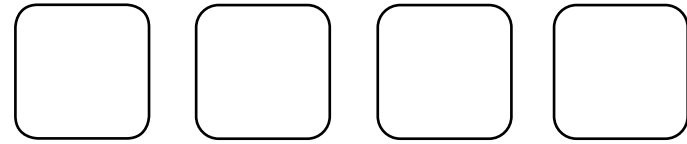

midnight ghost mist sunny

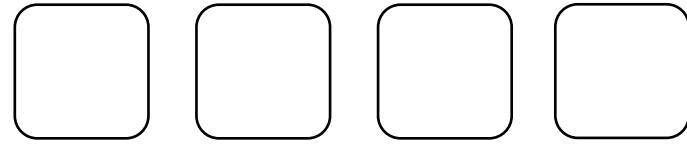

blush rouge salmon fire

BUZZIFELT

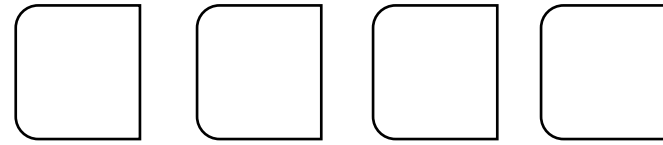

orange offwhite stonegrey lightblue

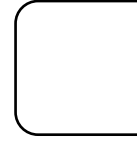

jeans

BIO PLASTIC



sage forest ocean navy



clay eggshell ochre blossom

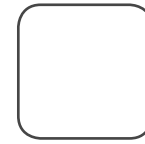

terracotta

CROUTON | SUSTAINABILITY

SCS IAQ GOLD

SCS Global Services certified for low VOC emissions with the most transparent indoor air quality (IAQ) standard for furniture and building materials. The Indoor Advantage and Indoor Advantage Gold standard aligns with both ANSI/BIFMA M7.1 and X7.1, and CA 01350. It is recognized by the EPA and GSA, and qualifies for many building rating systems, including LEED v4, BREEAM, WELL Building, and Living Building Challenge.

HPD TESTED

The HPD provides a chemical inventory of a building product and characterizes the level of concern about each ingredient. Most, if not all, of the chemicals in the product are disclosed by Pair, providing greater transparency in selecting products for buildings.

Untethered Power System:

This HPD includes the Pair product lines for workstations: SWING, SWING JR., SIMPLE BEAM, and OLLI. These systems are comparable in product attributes because they include a freestanding beam for power and data distribution. The power system can be used to delineate space and support various modes of individual and collaborative work.

Fabric:

This HPD covers fabric accessories to the Pair Product lines. Traverse from focus work to a collaborative environment in minutes by enhancing your workspace with Sidekicks offering screening and seating solutions designed to fit the needs of any workplace. Includes products: OLLI/SWING, POWER SLEEVE, BYOT POWER SLEEVE, FELT CABLE MANAGER, SWING BEAM MOUNTED SCREEN, SWING MODESTY, OLLI CUSHION, OLLI BUTTERFLY SCREEN, MIX DIVIDER SCREEN, HANGING BOARD, and HANGING SCREEN.

Metal & Wood:

This HPD covers wood and metal accessories to the Pair Product lines. Traverse from focus work to a collaborative environment in minutes by enhancing your workspace with Sidekicks and Elements designed to fit the needs of any workplace. Products included in this category: PLANTER HOOK, OLLI COAT RACK, OLLI FRAME, OLLI MEETING TABLE, STACKABLE CADDY, STACKABLE PLANTER, STACKABLE STORAGE, OLLI PLUG, BAG HOOK, TUCK, MIX INFILLS, SWING END PANEL, FADE CABLE CHASE, and NEST.





madebypair.com

Email hello@madebypair.com for more information.