

BYOT Wall Mounted.

Every seat is a good seat at the BYOT Wall Mounted table.

A new angle for your next meeting: BYOT Wall Mounted. Mount this table to any wall for the ultimate audio/video conferencing space. With Bento and the optional AV box, handle all your tech needs while keeping chords and gadgets tucked away. All the custom capabilities you love now with added functionality.

Build Your Own Table.



REVISED APRIL 2024



BYOT WALL MOUNTED

DIMENSIONS

Surface Depth:	Rectangular & D-Shape: 42" 48" 54" 60" Trapezoid: 54"/42" 60"/48"
Surface Width:	72" 84" 96" 108" 120" 144" 168"
Surface Thickness:	Veneer or Laminate 1.5"
Overall Height:	29"H
AV Box:	30"W x 7.5"D x 27.5"H
AV Box Access Door:	19.5"W x 18"H

STYLES

Surface Shape:	Trapezoid D-Shape Rectangular
Surface Edge:	Flat
Surface Corner:	Square Radius
Base Configuration:	Floating Wall Bracket + Base AV Wall Box + Base
Base:	Hashi Pillar Factory Farm Loop Mast Fin

DESIGN DETAILS

(1) Piece Top Wall + Base Support:	72"W - 120"W
(2) Piece Top Wall + Base Support:	144"W - 168"W
AV Wall Box Access Door:	Magnetic Closure
Trough Access:	Removable Trays
Glide:	1.25" Leveler

POWER

1 Bento + 3 Under Surface Power:	72"W - 108"W
2 Bento + 2 Under Surface Power:	120"W - 168"W
Infeed:	Softwired (UL Listed), 120"L, 20 AMPS Hardwired (UL Listed), 120"L, Straight Coupler
Infeed Location:	Beam at Wall Beam Center Drop Base

FINISHES *(Refer to Pair Palette)*

Surface:	Veneer Laminate
Edgeband:	Matching Exposed Baltic Birch Plywood
Base:	Metal
Trough:	Metal
Bento:	Metal
Grommet:	Black Brushed Nickel



BENTO

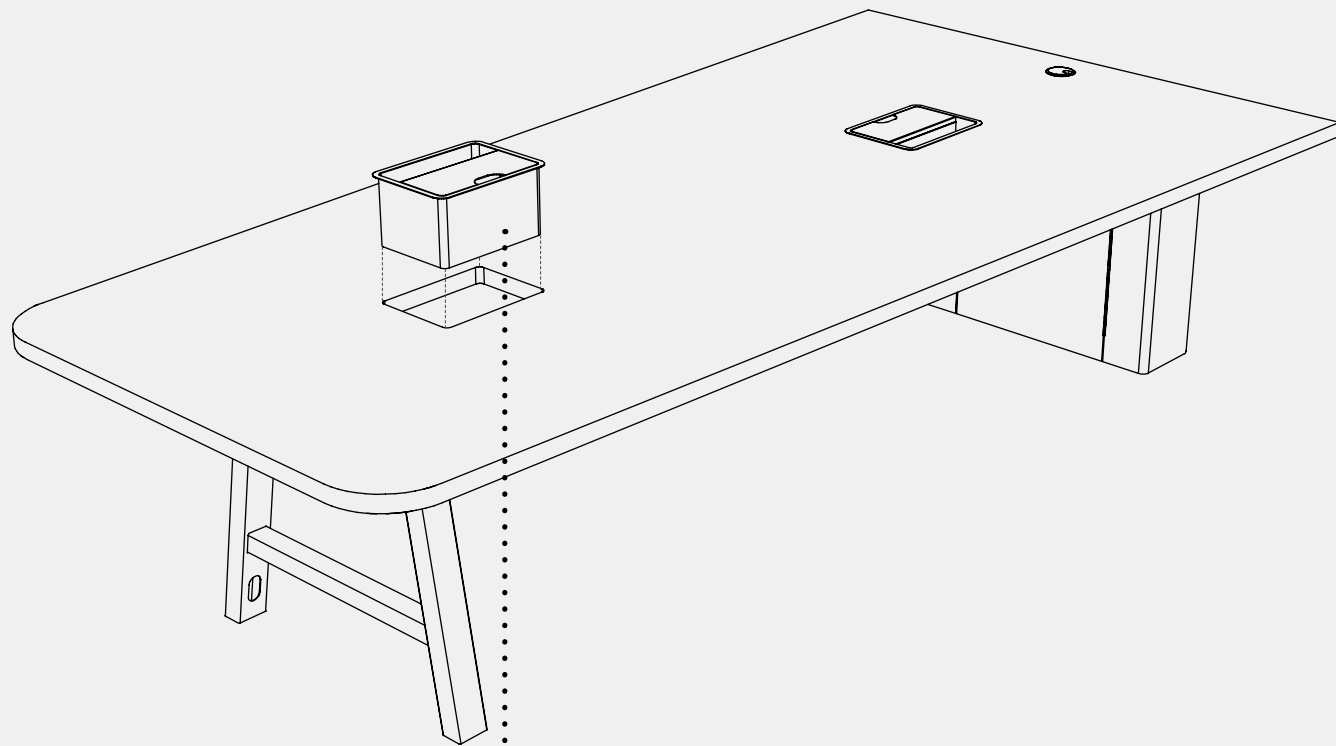
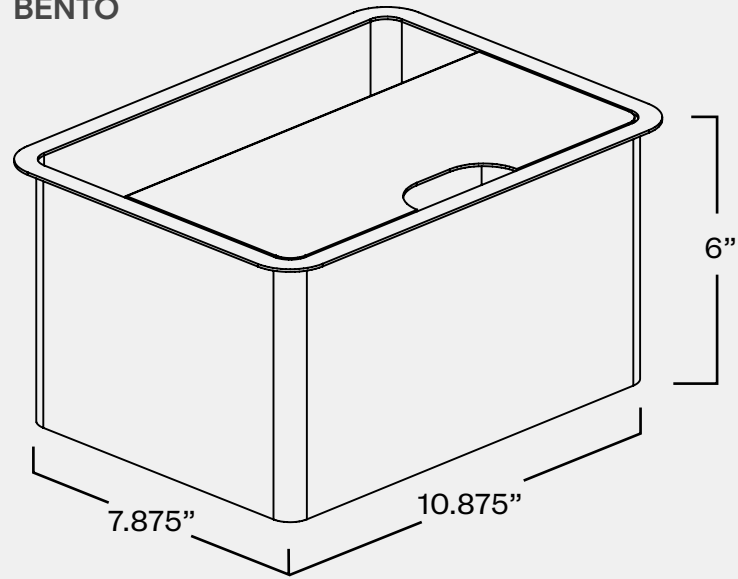

EASY INSTALLATION ·····

- Installs through table top
- Plugs into the below-surface 4-Trac power

ABOVE SURFACE POWER

Bento is a table top solution that offers flexible power and data without the cord clutter

PACKED WITH POWER

Conceal laptop chargers and much more in the BYOT trough and AV Box. Bento cordminders or grommet feed any additional power easily to the surface

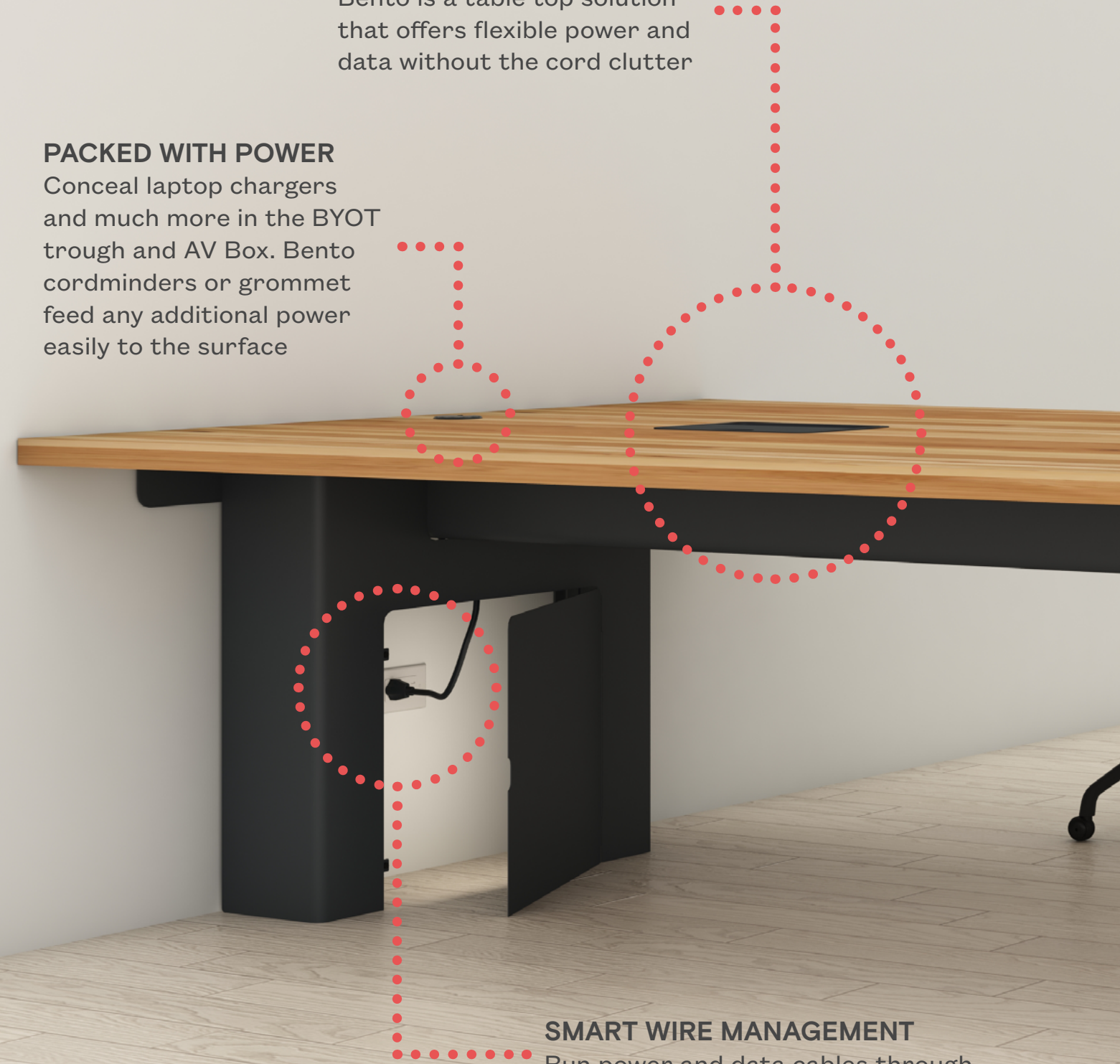

SMART WIRE MANAGEMENT

Run power and data cables through AV box

BYOT WALL MOUNTED | POWER

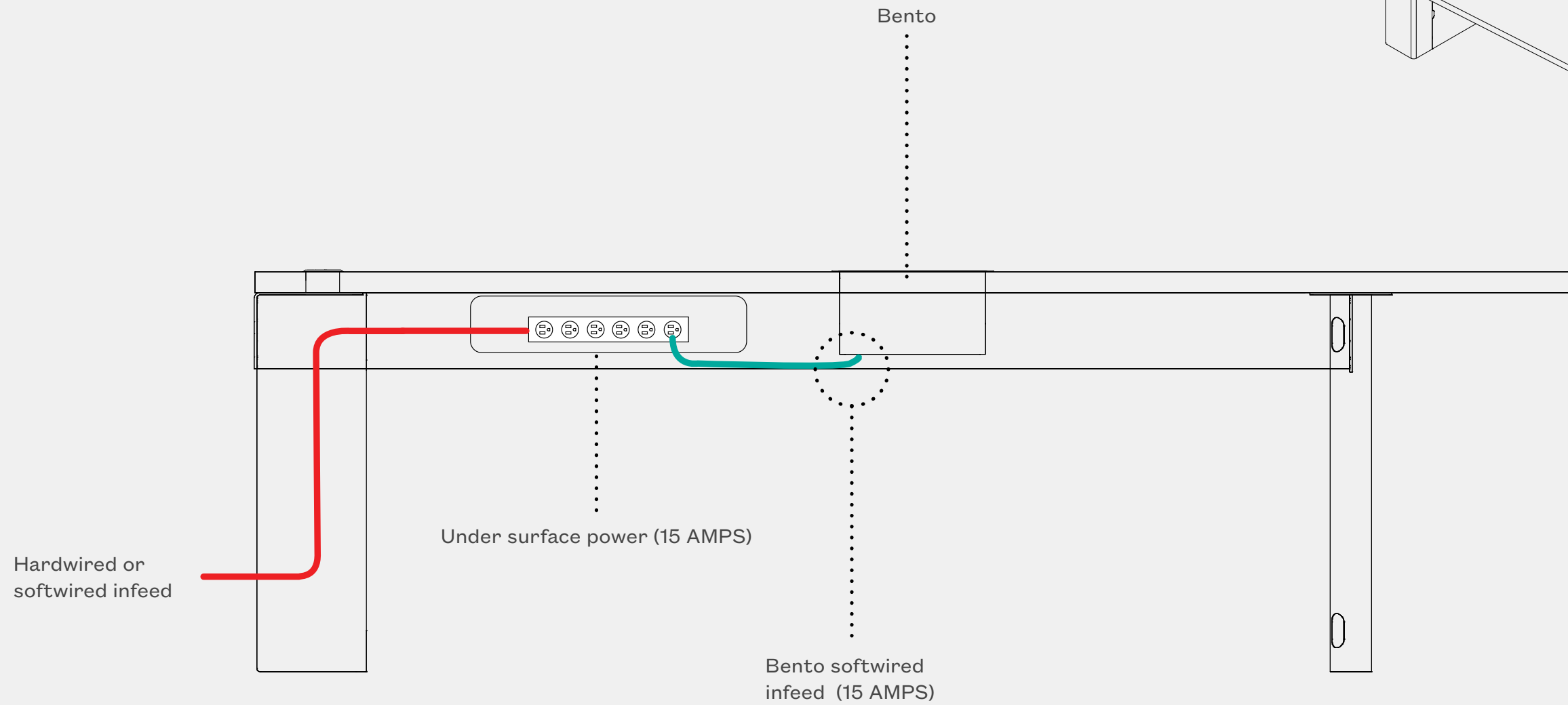

INFEED DETAILS

Softwired, 20 AMPS

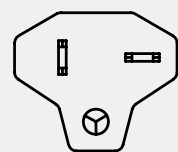
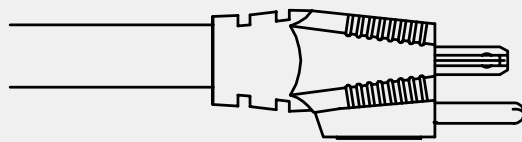

Hardwired, 1 Circuit

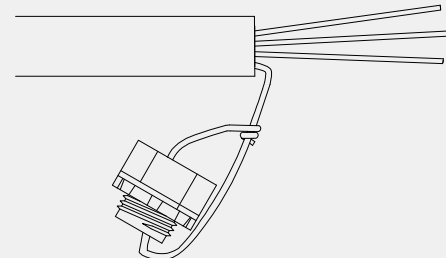

BYOT WALL MOUNTED | POWER + SURFACE CONFIGURATION

Shown on Trapezoid Shape surface

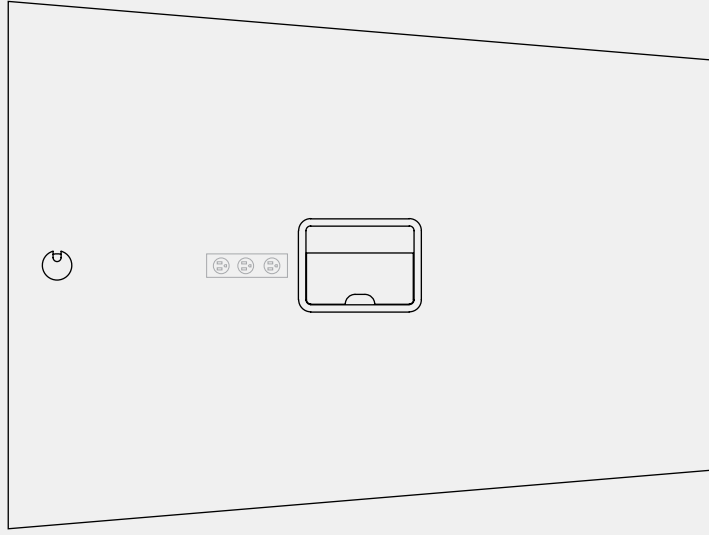

1 Piece | 1 Bento + 3 Under Surface Power | 72"W - 108"W

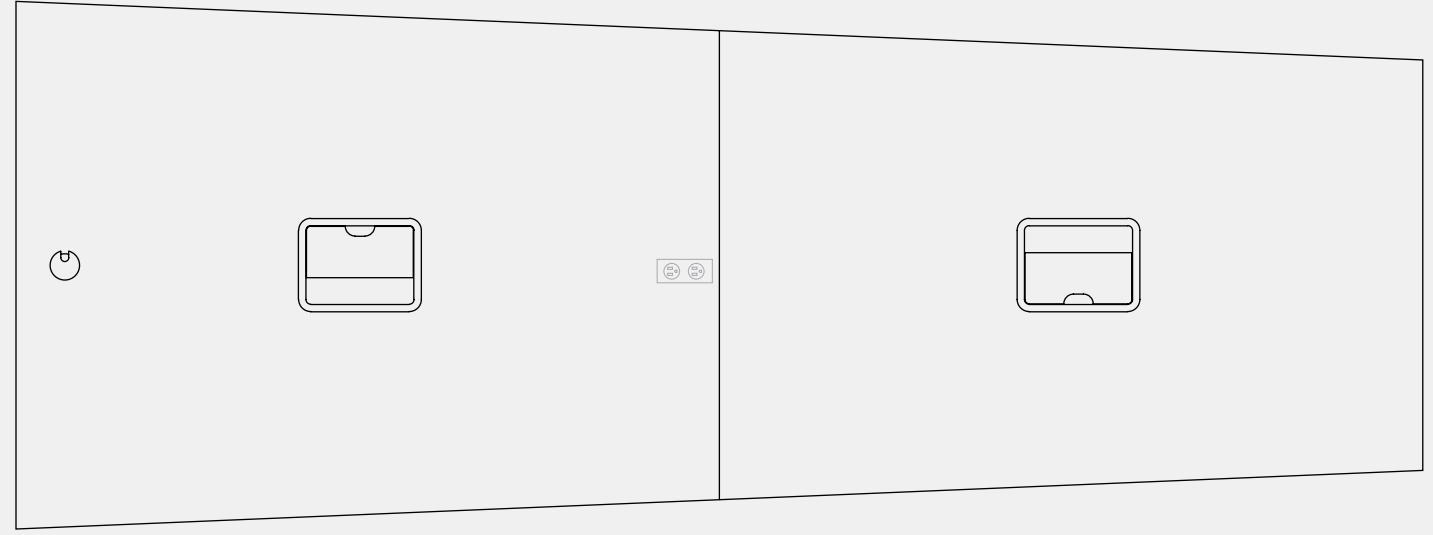

2 Piece | 2 Bento + 2 Under Surface Power | 144"W-168"W

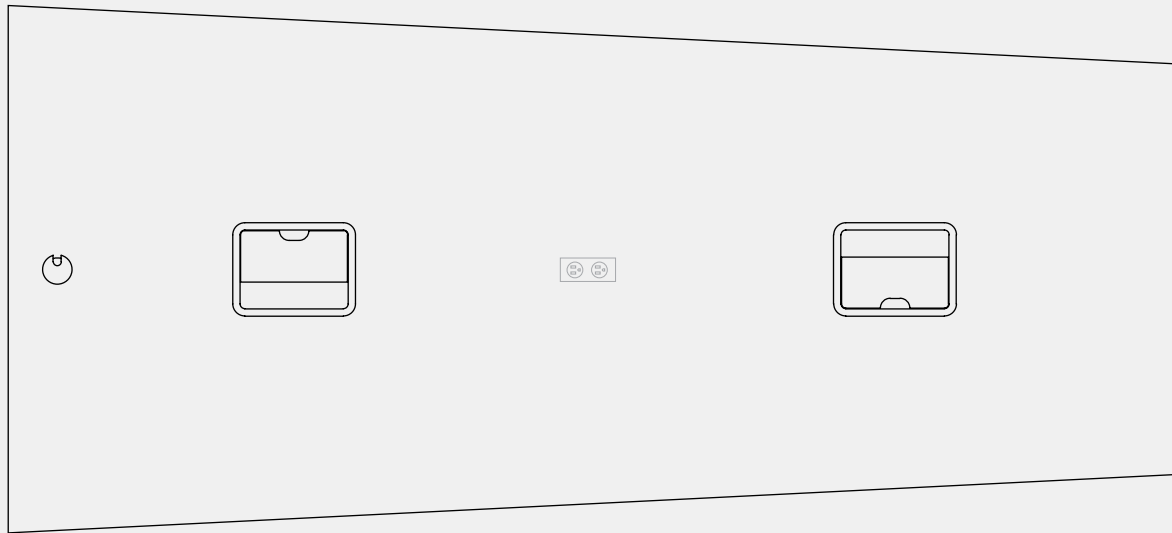

1 Piece | 2 Bento + 2 Under Surface Power | 120"W

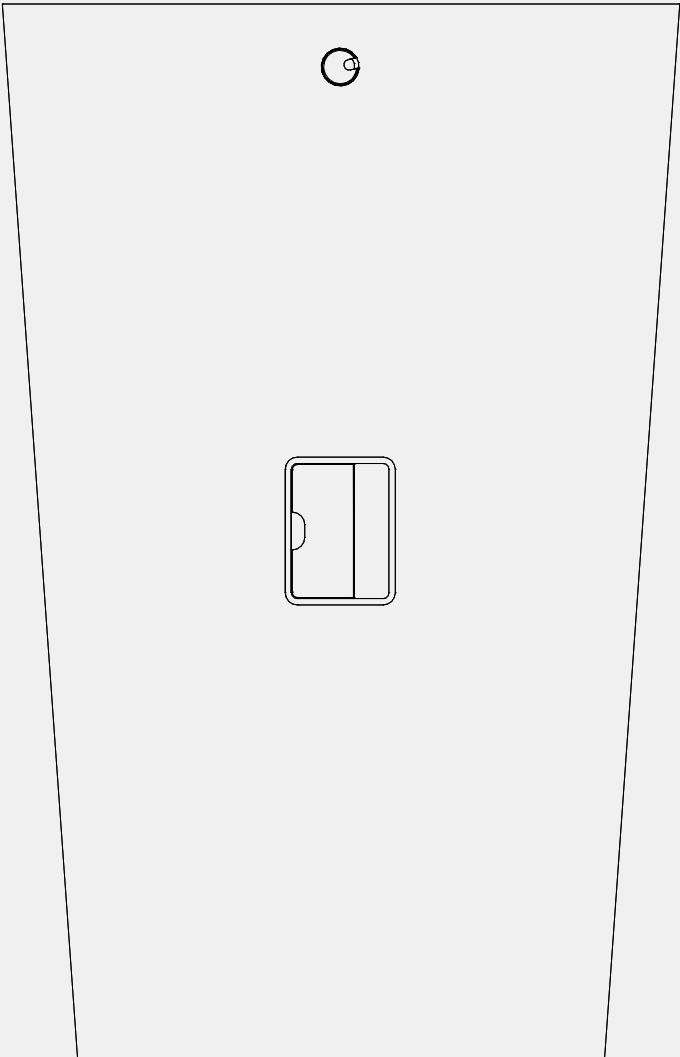

TRAPEZOID

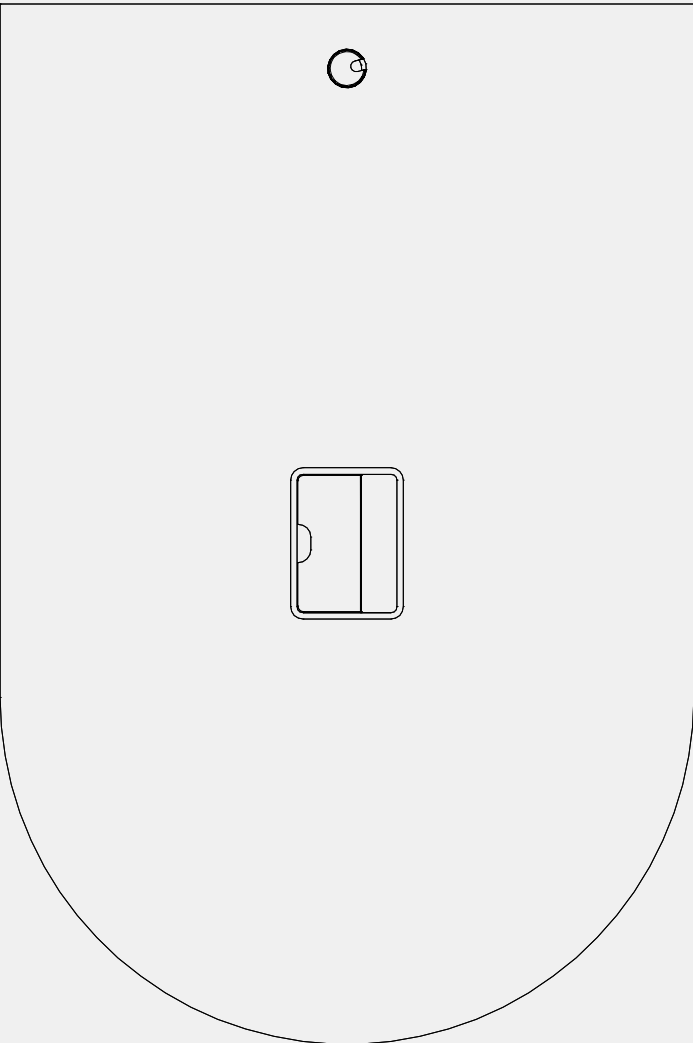

D-SHAPE

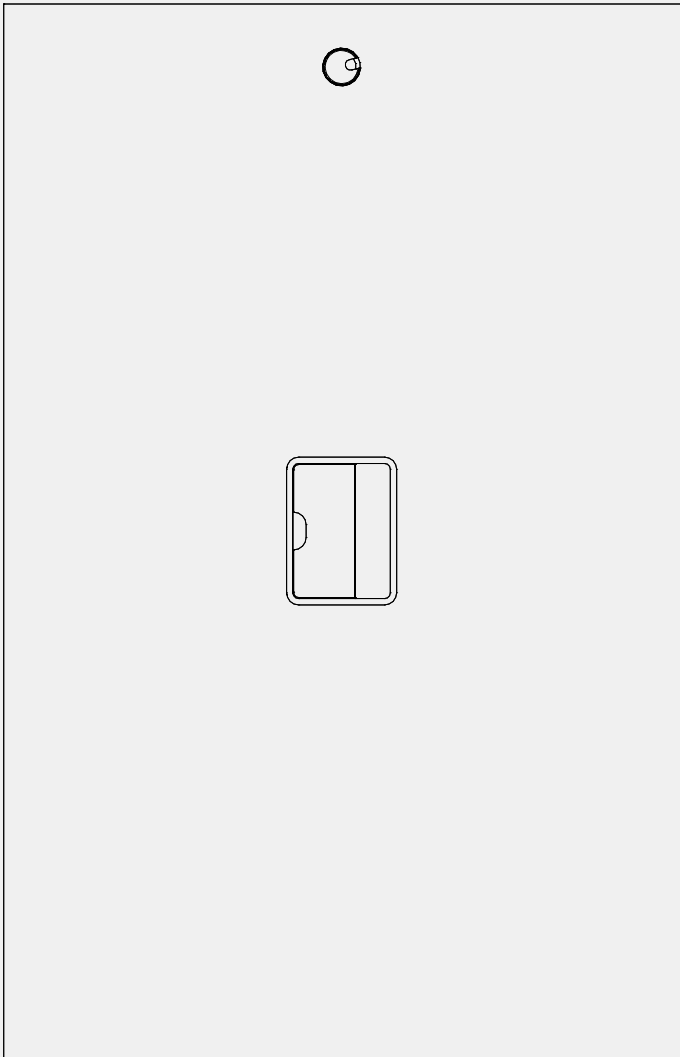

RECTANGLE

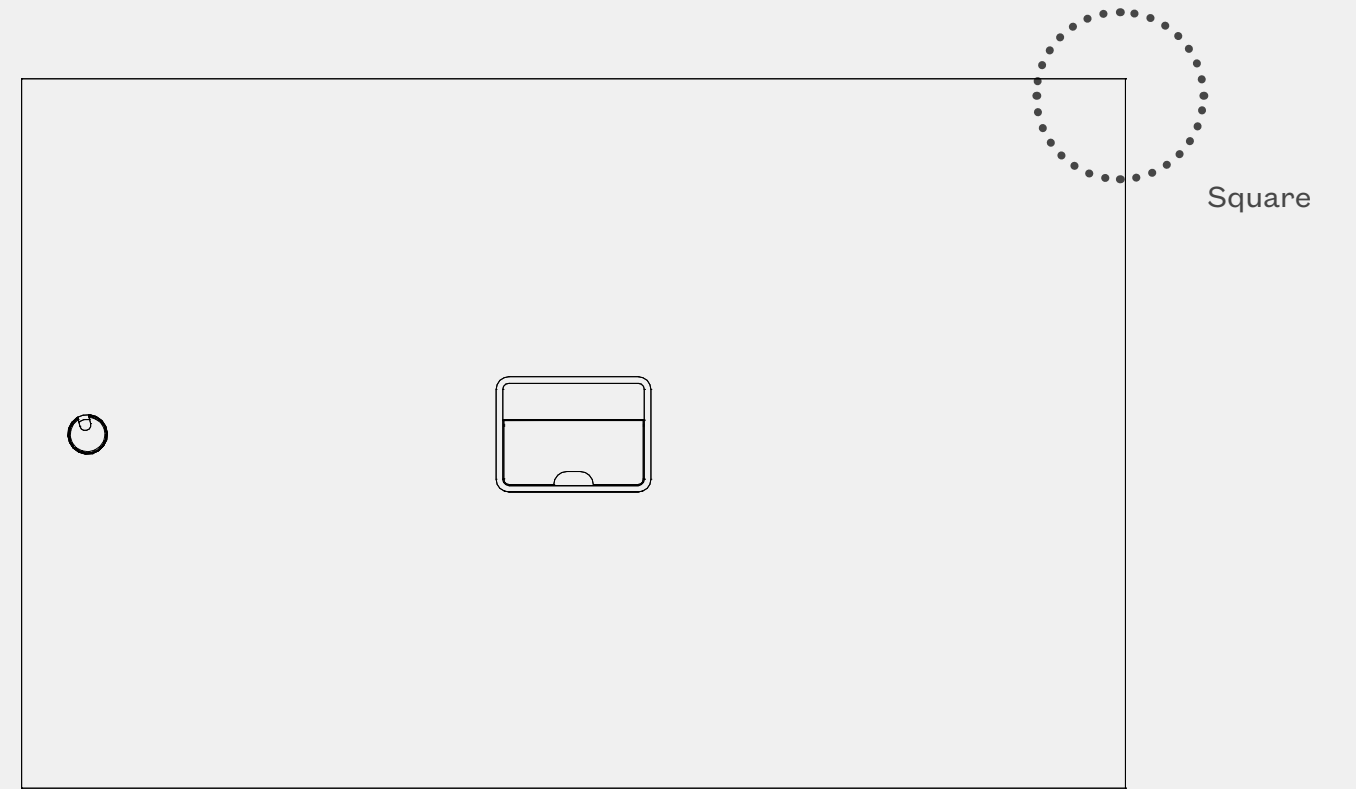
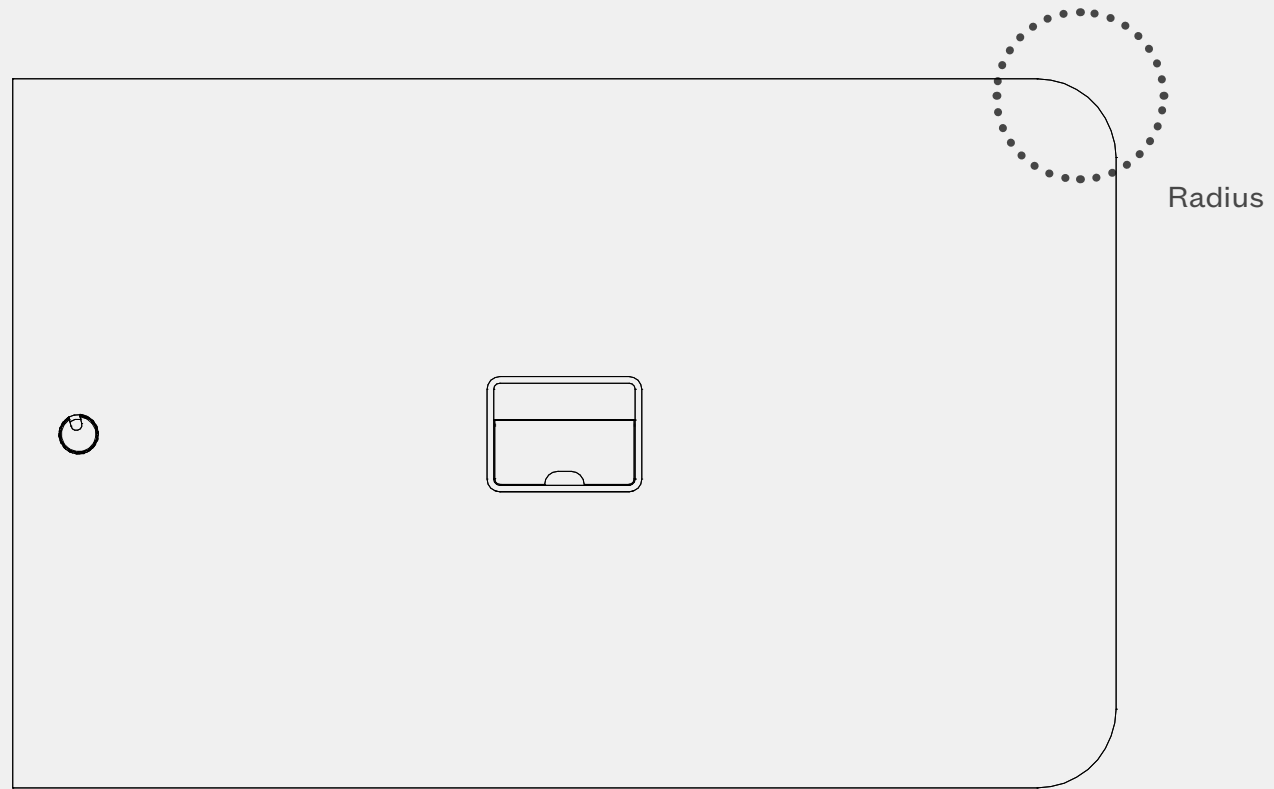
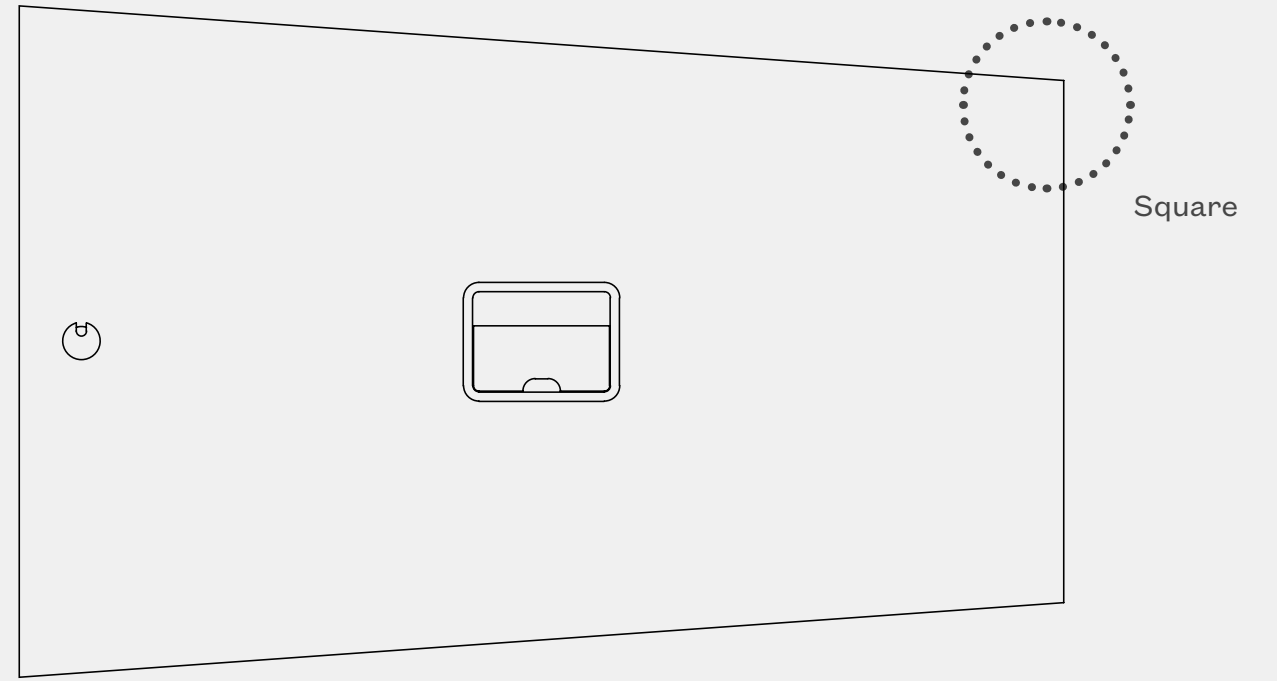
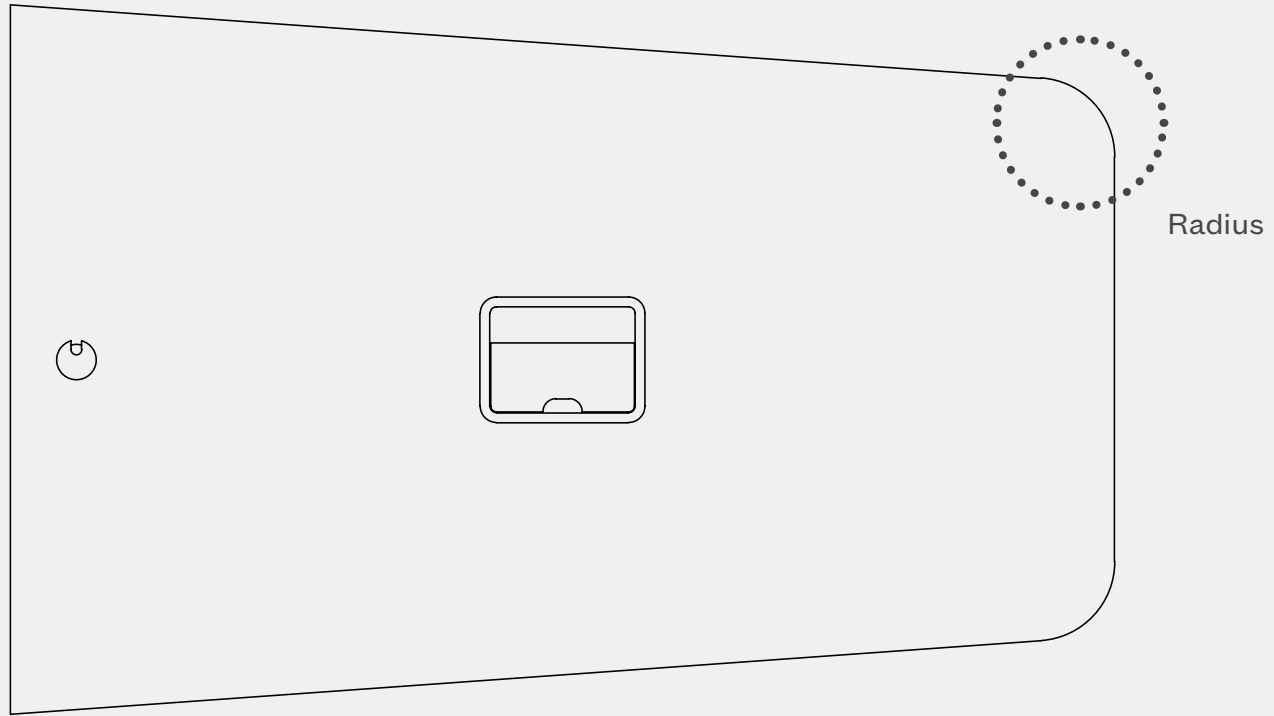

BYOTWALL MOUNTED | BASE CONFIGURATION

Floating Wall Bracket + Base



72"W - 84"W Only

AV Box + Base

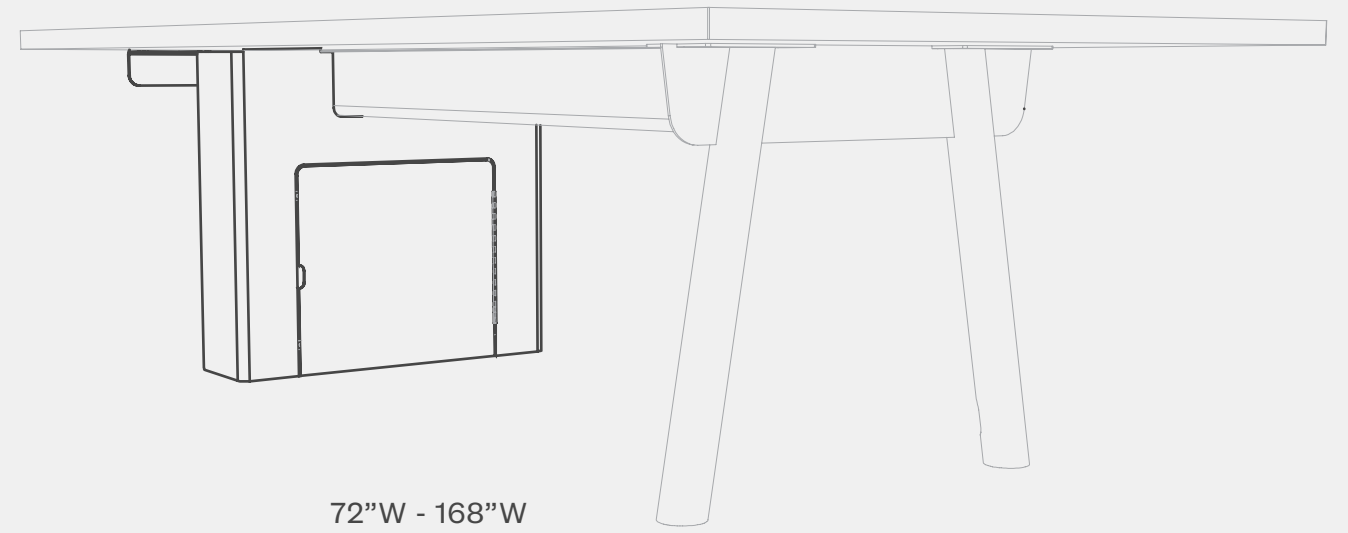

72"W - 168"W

BYOT WALL MOUNTED | BASE

HASHI

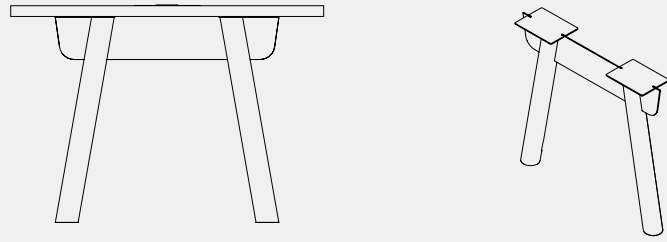

FARM

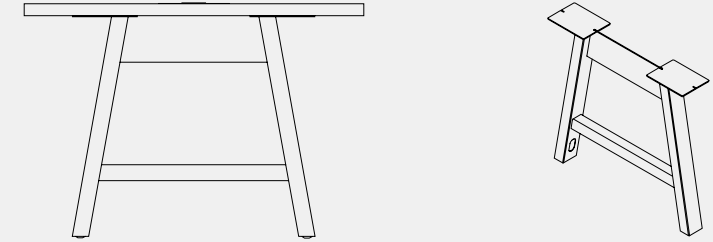

PILLAR

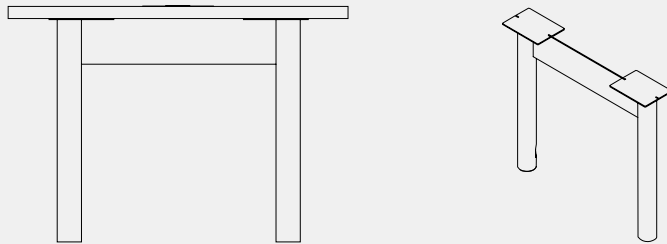

LOOP

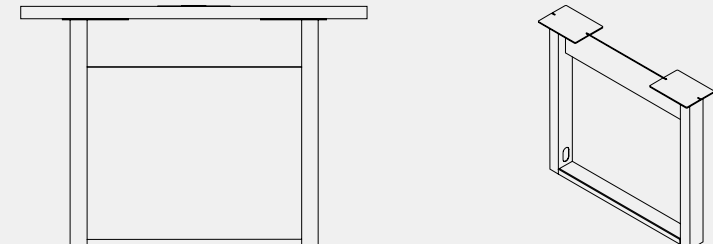

FACTORY

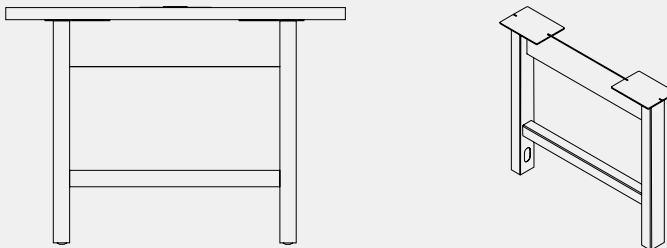

MAST

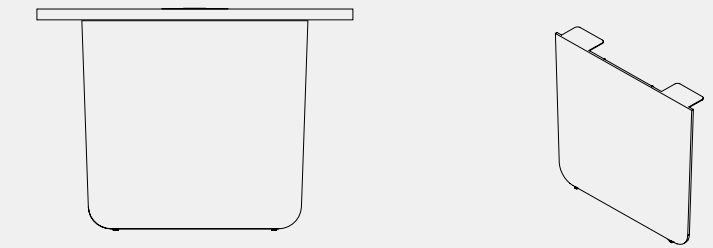

FIN

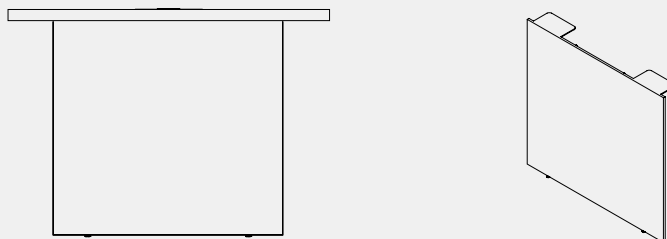

MAGNETIC CABLE CHASE
**applicable to Fin and Mast leg styles only*

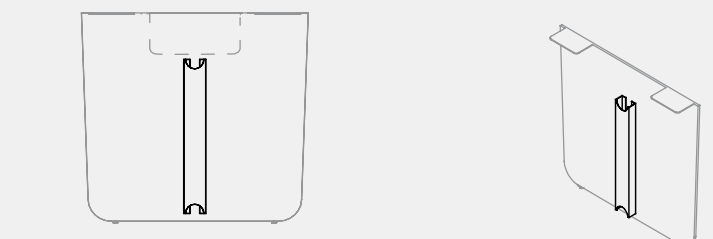

VENEER

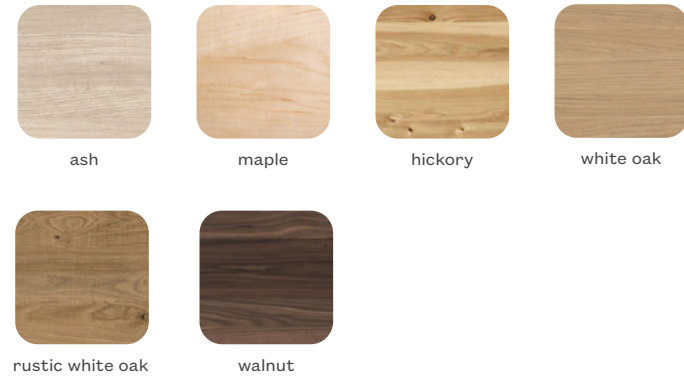

WRAPPED LAMINATE

**woodgrains contain texture*

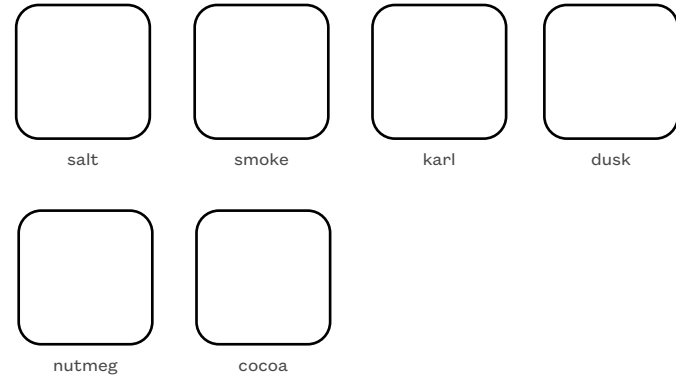

SOFT TOUCH LAMINATE

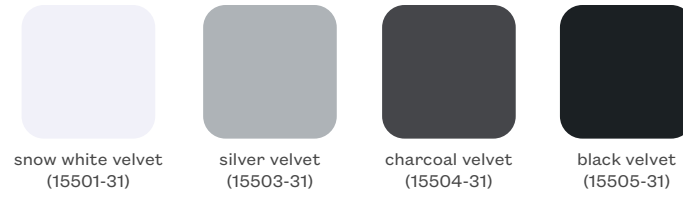

LAMINATE



METAL



WOOL

**additional colorways available at a premium*

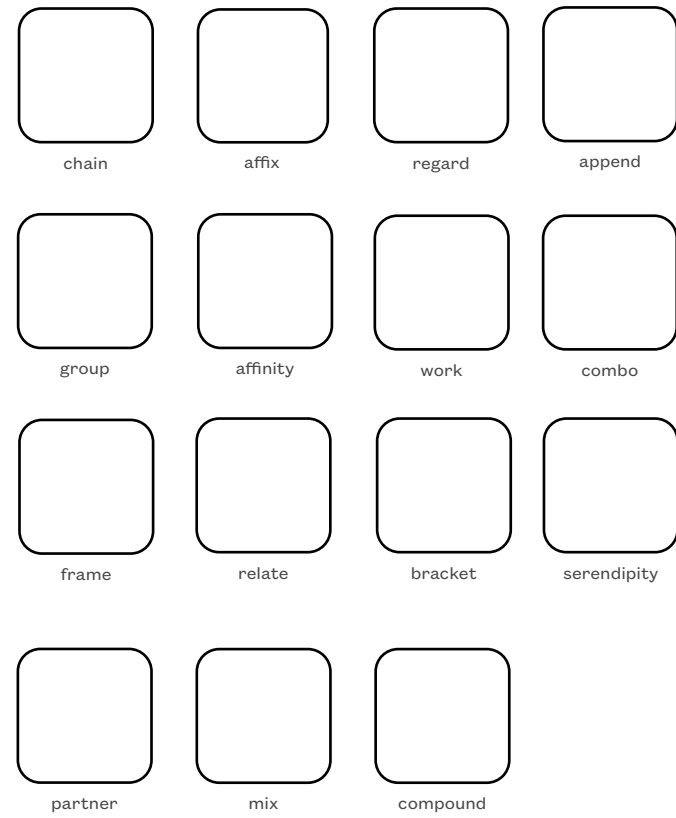

PET

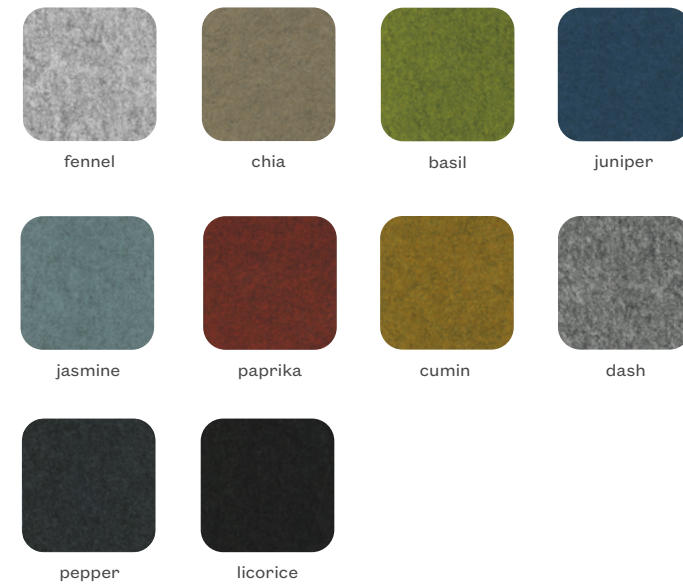

MISCELLANEOUS

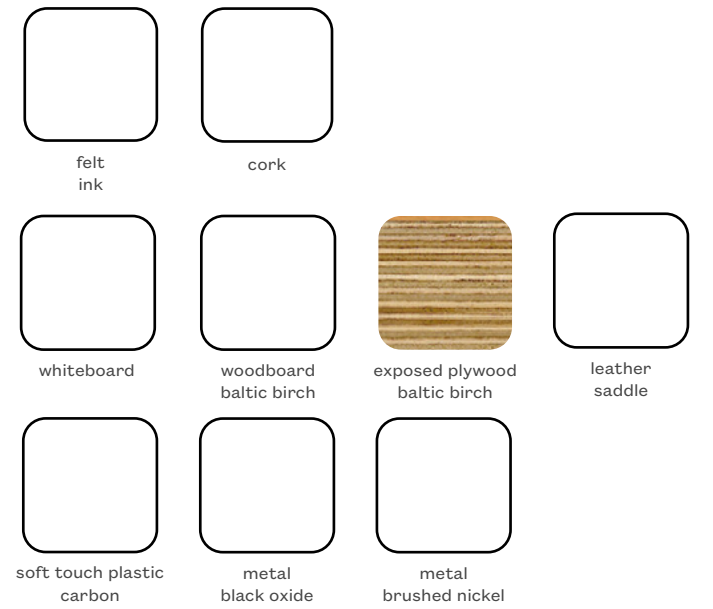

SOFT TOUCH GLASS

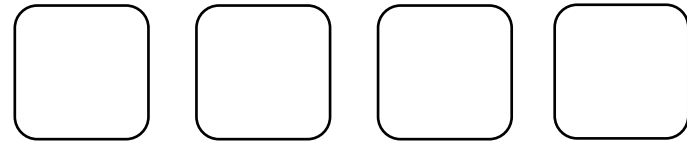

olive storm ash gumby

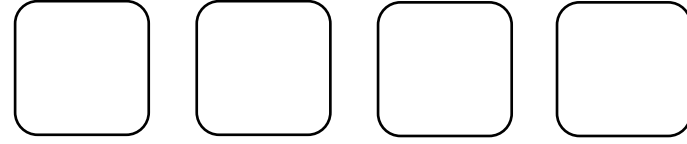

wave apollo carbon abyss

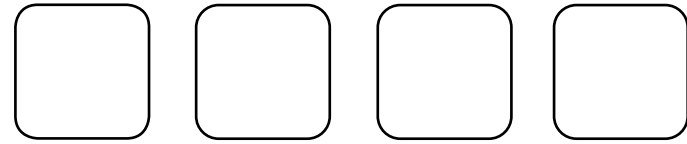

midnight ghost mist sunny

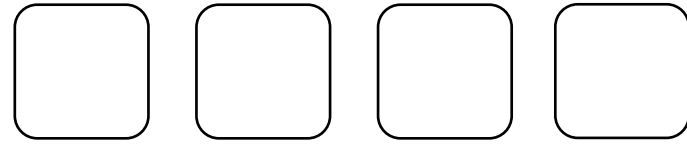

blush rouge salmon fire

BUZZIFELT

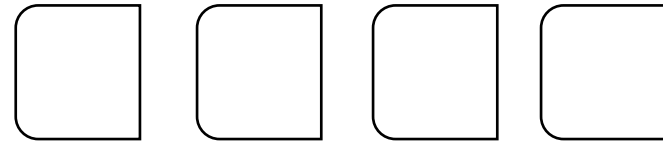

orange offwhite stonegrey lightblue

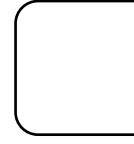

jeans

BIO PLASTIC



sage forest ocean cobalt



clay eggshell ochre blossom



terracotta onyx

BYOT WALL MOUNTED | SUSTAINABILITY

SCS IAQ GOLD

SCS Global Services certified for low VOC emissions with the most transparent indoor air quality (IAQ) standard for furniture and building materials. The Indoor Advantage and Indoor Advantage Gold standard aligns with both ANSI/BIFMA M7.1 and X7.1, and CA 01350. It is recognized by the EPA and GSA, and qualifies for many building rating systems, including LEED v4, BREEAM, WELL Building, and Living Building Challenge.

HPD TESTED

The HPD provides a chemical inventory of a building product and characterizes the level of concern about each ingredient. Most, if not all, of the chemicals in the product are disclosed by Pair, providing greater transparency in selecting products for buildings.

Untethered Power System:

This HPD includes the Pair product lines for workstations: SWING, SWING JR., SIMPLE BEAM, and OLLI. These systems are comparable in product attributes because they include a freestanding beam for power and data distribution. The power system can be used to delineate space and support various modes of individual and collaborative work.

Fabric:

This HPD covers fabric accessories to the Pair Product lines. Traverse from focus work to a collaborative environment in minutes by enhancing your workspace with Sidekicks offering screening and seating solutions designed to fit the needs of any workplace. Includes products: OLLI/SWING, POWER SLEEVE, BYOT POWER SLEEVE, FELT CABLE MANAGER, SWING BEAM MOUNTED SCREEN, SWING MODESTY, OLLI CUSHION, OLLI BUTTERFLY SCREEN, MIX DIVIDER SCREEN, HANGING BOARD, and HANGING SCREEN.

Metal & Wood:

This HPD covers wood and metal accessories to the Pair Product lines. Traverse from focus work to a collaborative environment in minutes by enhancing your workspace with Sidekicks and Elements designed to fit the needs of any workplace. Products included in this category: PLANTER HOOK, OLLI COAT RACK, OLLI FRAME, OLLI MEETING TABLE, STACKABLE CADDY, STACKABLE PLANTER, STACKABLE STORAGE, OLLI PLUG, BAG HOOK, TUCK, MIX INFILLS, SWING END PANEL, FADE CABLE CHASE, and NEST.





Email hello@madebypair.com for more information.