

Slice.

A responsible desktop companion to support your daily work habits. Utilizing 3D printed technology, slice boasts a cork lined tray and hook bioderived from corn starch and recycled food packaging waste. The tray features an expressive squiggle detail that holds pens, props up phones, all while supporting a cork privacy panel. Select from an array of colors to create a unique look.

DIMENSIONS

Screen Overall:	24"W x 15"H
Screen Thickness:	0.75"
Tray Overall:	9"W x 6"D x 2"H
Hook Overall:	0.5"W x 2.65"D x 3"H

DESIGN DETAILS

Corner:	Radius
Mount Style:	Micro Suction Pads

FINISHES *(Refer to Pair Palette)*

Screen:	Cork
Tray:	Bio Plastic
Tray Liner:	Cork
Hook:	Bio Plastic

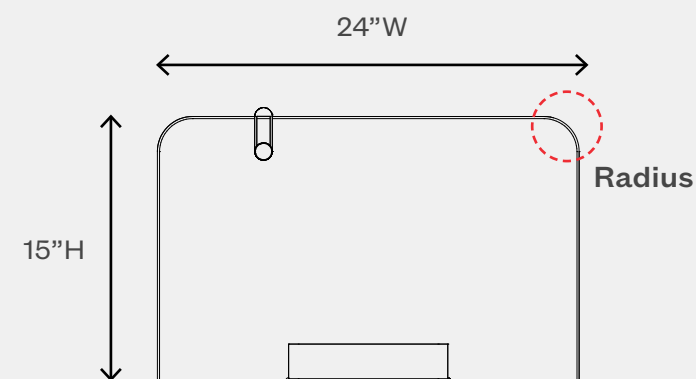
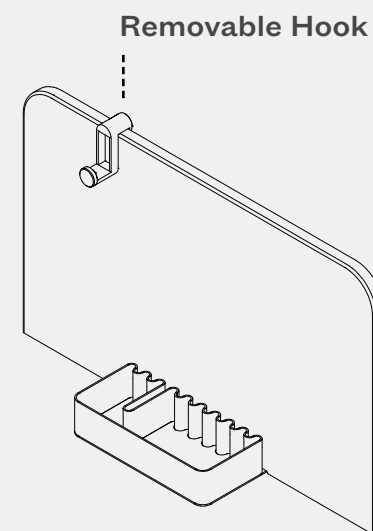

VENEER

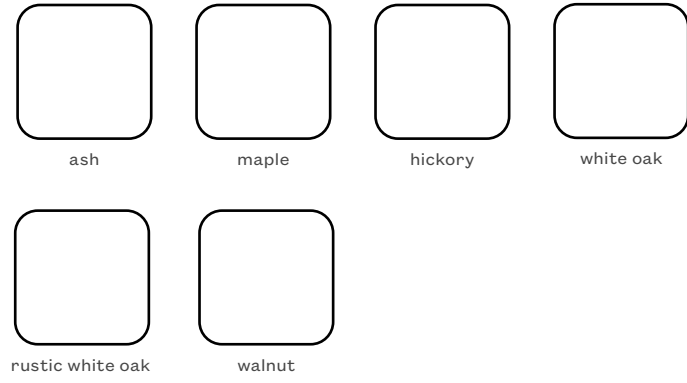

WRAPPED LAMINATE

**woodgrains contain texture*

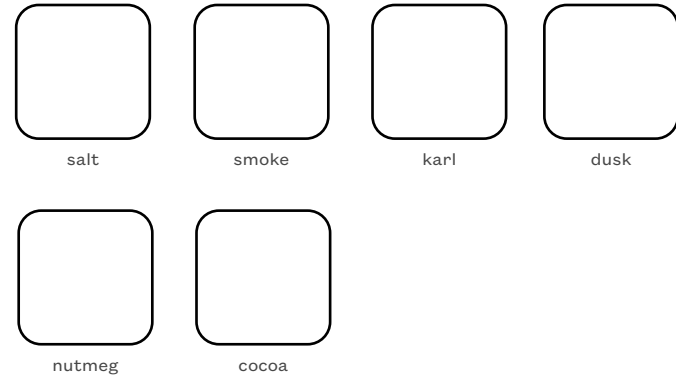

SOFT TOUCH LAMINATE



LAMINATE

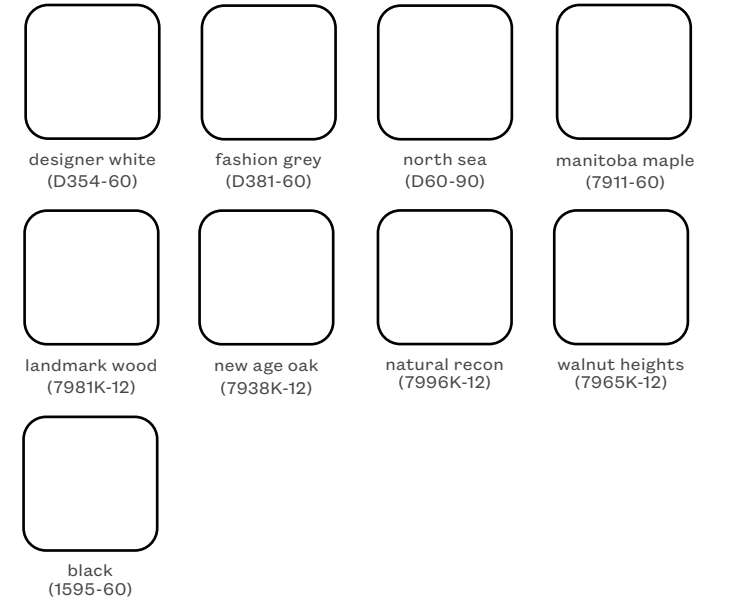

METAL



WOOL

**additional colorways available at a premium*

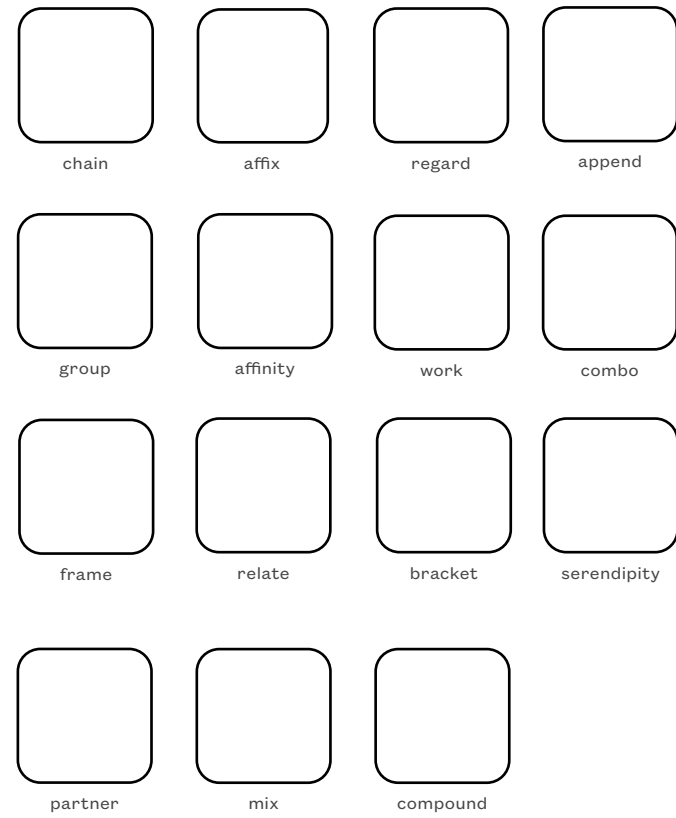

PET

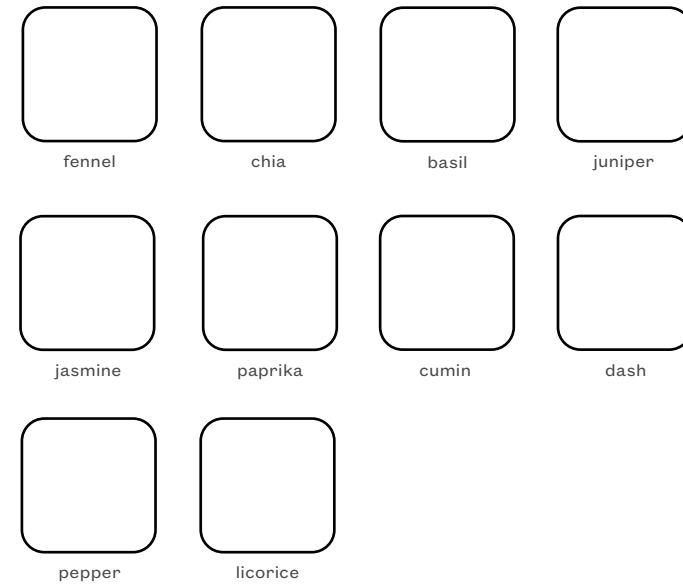

MISCELLANEOUS

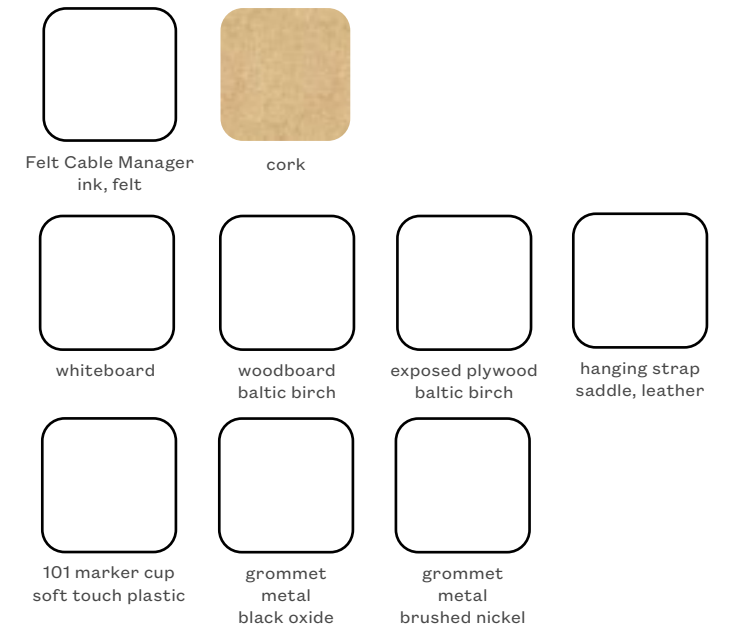

SOFT TOUCH GLASS

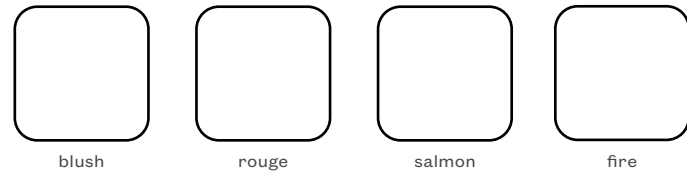
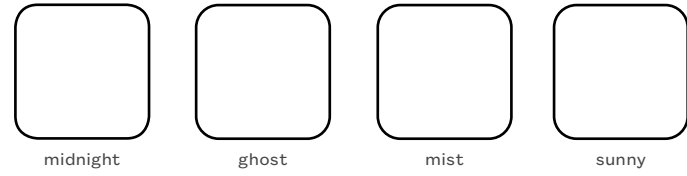
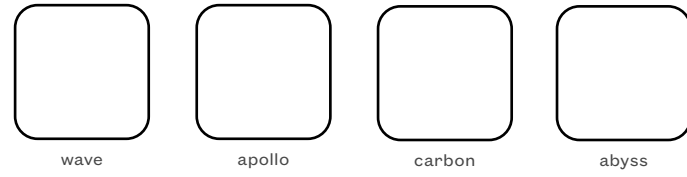
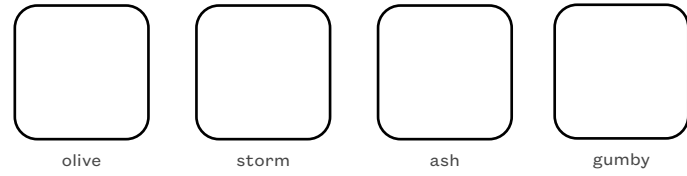

BUZZIFELT

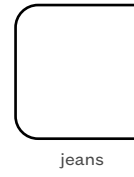
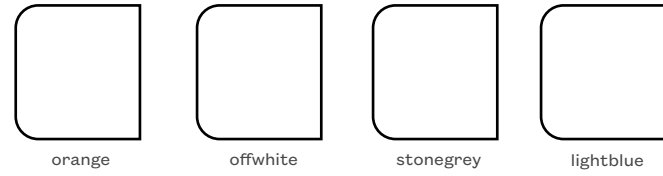

BIO PLASTIC

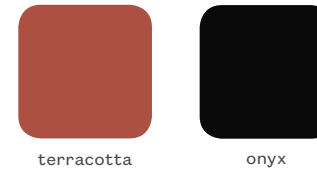
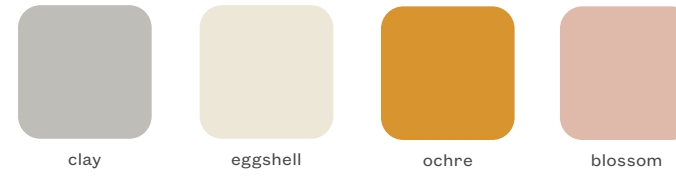
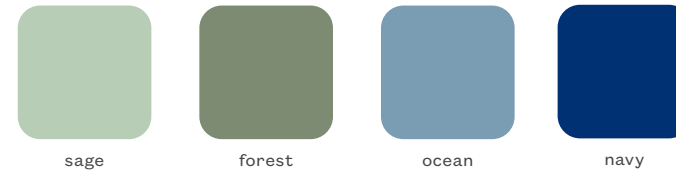

SLICE | SUSTAINABILITY

SCS IAQ GOLD

SCS Global Services certified for low VOC emissions with the most transparent indoor air quality (IAQ) standard for furniture and building materials. The Indoor Advantage and Indoor Advantage Gold standard aligns with both ANSI/BIFMA M7.1 and X7.1, and CA 01350. It is recognized by the EPA and GSA, and qualifies for many building rating systems, including LEED v4, BREEAM, WELL Building, and Living Building Challenge.

HPD TESTED

The HPD provides a chemical inventory of a building product and characterizes the level of concern about each ingredient. Most, if not all, of the chemicals in the product are disclosed by Pair, providing greater transparency in selecting products for buildings.

Untethered Power System:

This HPD includes the Pair product lines for workstations: SWING, SWING JR., SIMPLE BEAM, and OLLI. These systems are comparable in product attributes because they include a freestanding beam for power and data distribution. The power system can be used to delineate space and support various modes of individual and collaborative work.

Fabric:

This HPD covers fabric accessories to the Pair Product lines. Traverse from focus work to a collaborative environment in minutes by enhancing your workspace with Sidekicks offering screening and seating solutions designed to fit the needs of any workplace. Includes products: OLLI/SWING, POWER SLEEVE, BYOT POWER SLEEVE, FELT CABLE MANAGER, SWING BEAM MOUNTED SCREEN, SWING MODESTY, OLLI CUSHION, OLLI BUTTERFLY SCREEN, MIX DIVIDER SCREEN, HANGING BOARD, and HANGING SCREEN.

Metal & Wood:

This HPD covers wood and metal accessories to the Pair Product lines. Traverse from focus work to a collaborative environment in minutes by enhancing your workspace with Sidekicks and Elements designed to fit the needs of any workplace. Products included in this category: PLANTER HOOK, OLLI COAT RACK, OLLI FRAME, OLLI MEETING TABLE, STACKABLE CADDY, STACKABLE PLANTER, STACKABLE STORAGE, OLLI PLUG, BAG HOOK, TUCK, MIX INFILLS, SWING END PANEL, FADE CABLE CHASE, and NEST.





madebypair.com

Email hello@madebypair.com for more information.